



KICK Monarch 48"
(Brown/Black/Gray)
Foosball Table
Assembly Instructions



Assembly Instructions

WARNING: TWO ADULTS NEEDED TO ASSEMBLE SOCCER TABLE



Official Website of KICK Foosball Tables



IF YOUR TABLE HAS DAMAGES, MISSING PARTS, OR YOU ARE NOT **100%** SATISFIED PLEASE CONTACT **KICK, NOT THE RESELLER.**

← SCAN THIS QR CODE TO CONTACT US IF YOU FACE ANY ISSUES.

FOR THE LATEST INSTRUCTION MANUALS, VIDEOS, TABLE ASSEMBLY INFO, DIFFERENT GOALIE SETUPS, PLAYER TYPES, AND OTHER HELPFUL TIPS - PLEASE VISIT THE LINK BELOW OR SCAN THIS QR CODE →

www.KICKFoosballTables.com/Instructions/

















CONTACT INFORMATION:

Email: Support@KICKFoosballTables.com
Website: www.KICKFoosballTables.com
Phone: 1 (866) 844-KICK (5425) or (210) 664-8934

MAILING ADDRESS:

KICK Sports
PO Box 790311
San Antonio, Texas 78279















PARTS LIST

<p>H1</p>  <p>1/4"x1-1/4" BOLT 8 pcs</p>	<p>H2</p>  <p>1/4"x2" BOLT 8 pcs</p>	<p>H3</p>  <p>5/16"x1-3/4" BOLT 4 pcs</p>
<p>H4</p>  <p>1/4" WASHER 16 pcs</p>	<p>H5</p>  <p>5/16" WASHER 8 pcs</p>	<p>H6</p>  <p>3/8" WASHER 2 pcs</p>
<p>H7</p>  <p>1/4"x1/2" NUT 2 pcs</p>	<p>H8</p>  <p>5/16" HANDLE NUT 4 pcs</p>	<p>H9</p>  <p>CYLINDRICAL NUT 8 pcs</p>
<p>H10</p>  <p>CYLINDRICAL NUT(PLASTIC) 4 pcs</p>	<p>H11</p>  <p>1-1/2"ROUND HEAD SCREW 4 pcs</p>	<p>H12</p>  <p>1-1/8"ROUND HEAD SCREW 4 pcs</p>
<p>H13</p>  <p>1" FLAT HEAD SCREW 4 pcs</p>	<p>H14</p>  <p>25-1/2" BOLT 1 PC</p>	<p>H15</p>  <p>SCREW (used to install handle) 8 pcs</p>
<p>S1</p>  <p>5/8"FLAT HEAD SCREW 24 pcs</p>	<p>A1</p>  <p>SOCCER BALL 2 pcs</p>	<p>A2</p>  <p>TOOL 2 pcs</p>

PARTS LIST

<p>P1</p>  <p>SIDE PANEL 2 pcs</p>	<p>P2</p>  <p>END PANEL 2 pcs</p>	<p>P3</p>  <p>PLAYING FIELD 1 pc</p>
<p>P4A</p>  <p>LEFT STRAIGHT LEG 1 PC</p>	<p>P4B</p>  <p>RIGHT STRAIGHT LEG 1 PC</p>	<p>P5A</p>  <p>LEFT ANGLED LEG 1 PC</p>
<p>P5B</p>  <p>RIGHT ANGLED LEG 1 PC</p>	<p>P6</p>  <p>LEG PANEL 2 PCS</p>	<p>P7</p>  <p>PLAYFIELD SUPPORT BRACE 2 PCS</p>
<p>P8</p>  <p>HANDLE 8 pcs</p>	<p>P9</p>  <p>ROD END CAP 8 pcs</p>	<p>P10</p>  <p>SLIDE SCORER 2 pcs</p>
<p>P11</p>  <p>WHEELS 2 pcs</p>	<p>P12</p>  <p>LEG LEVELER 4 pcs</p>	<p>P13</p>  <p>LEG BOARD 2 pcs</p>
<p>P14</p>  <p>TUBE 1 pc</p>	<p>#1a</p>  <p>TRIANGLE a 2 pcs</p>	<p>#1b</p>  <p>TRIANGLE b 2 pcs</p>

PARTS LIST

<p>#2a</p>  <p>L STYLE PLASTIC a 2 pcs</p>	<p>#2b</p>  <p>L STYLE PLASTIC b 2 pcs</p>	<p>#3a</p>  <p>LONG PLASTIC a 2 pcs</p>
<p>#3b</p>  <p>LONG PLASTIC b 2 pcs</p>	<p>P15</p>  <p>PLUGS (to cover the hole of the screws S1) 1 set</p>	
		
<p>C1</p>  <p>5 PLAYER ROD 2 pcs</p>	<p>C2</p>  <p>3&1 PLAYER ROD 4 pcs</p>	<p>C3</p>  <p>2 PLAYER ROD 2 pcs</p>
<p>C4</p>  <p>RUBBER BUSHING 16 pcs</p>	<p>C5</p>  <p>PLASTIC ROD WASHERS 16 pcs</p>	<p>C6</p>  <p>BOLT(used to install men) 26 pcs</p>
<p>C7</p>  <p>LOCKING NUT (used to install men) 26 pcs</p>	<p>C8</p>  <p>HOME MEN 13 pcs</p>	<p>C9</p>  <p>AWAY MEN 13 pcs</p>

Assembly Instructions

WARNING: TWO ADULTS NEEDED TO ASSEMBLE SOCCER TABLE

1. ATTACH THE TWO END PANELS **P2** TO THE SIDE PANELS **P1** WITH BOLTS **H1** AND WASHERS **H4**. **FIGURE 1~4** .

Do not over-tighten hardware!

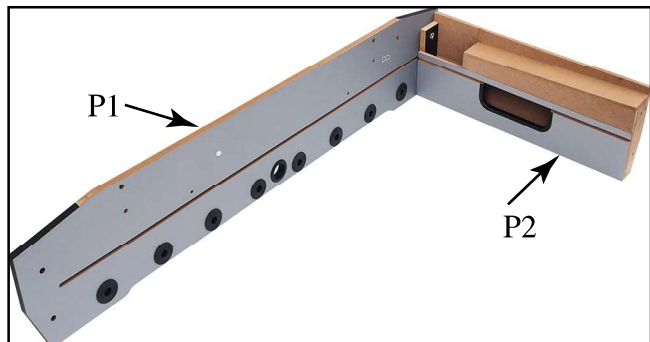

1

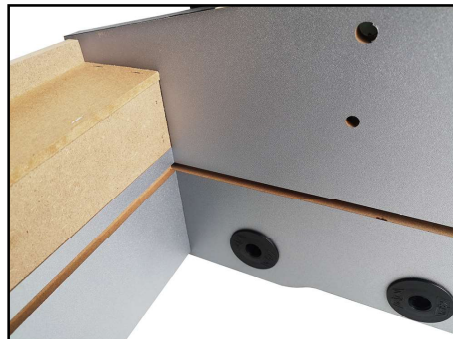

2

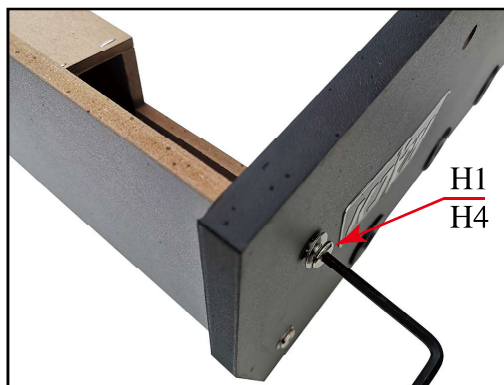

3



4

2. SLIDE PLAYFIELD **P3** INTO THE GROOVE ON THE SIDE AND END PANELS SEE **FIGURE 5~6** .



5



6

Assembly Instructions

WARNING: TWO ADULTS NEEDED TO ASSEMBLE SOCCER TABLE

3. ATTACH THE OTHER SIDE PANEL WITH BOLTS **H1** AND WASHERS **H4** . SEE **FIGURE 7~9** .
Tighten all the hardware at this time



7



8

4. INSERT THE NUT **H10** INTO THE HOLE OF THE SUPPORT BRACES **P7** .
PLACE THE PLAYFIELD SUPPORTS P7 ON THE BOTTOM OF THE PLAYFIELD AND ATTACH IT WITH SCREWS **H11** . SEE **FIGURE 10~12** .

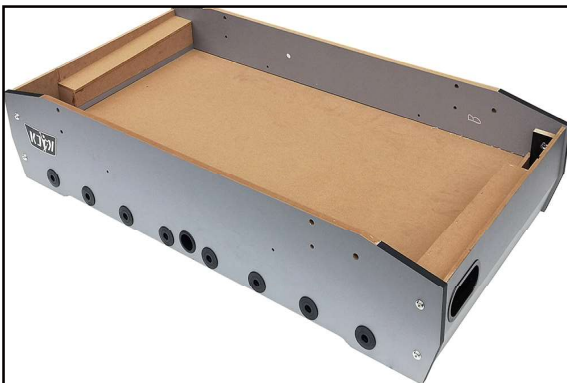

9

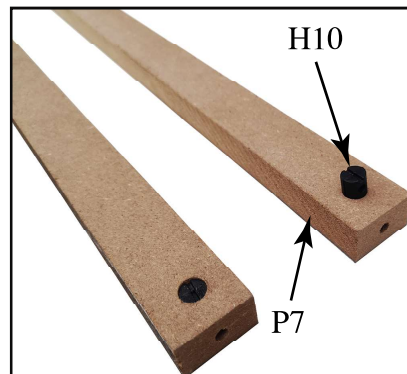

10

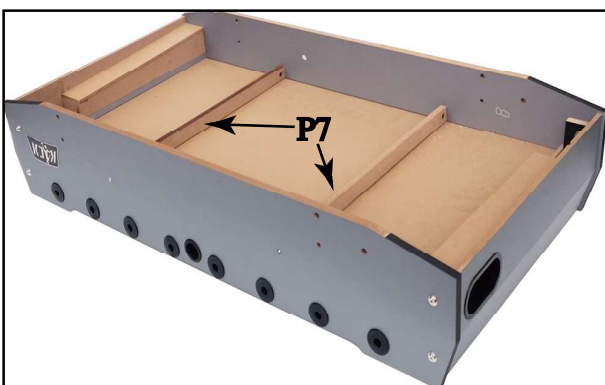

11



12

Assembly Instructions

WARNING: TWO ADULTS NEEDED TO ASSEMBLE SOCCER TABLE

5. ATTACH THE STRAIGHT LEGS **P4A&P4B** AND ANGLED LEGS **P5A&P5B** TO THE TABLE BY USING BOLTS **H3**, WASHERS **H5** AND HANDLE NUTS **H8** .SEE **FIGURE 13~14** .

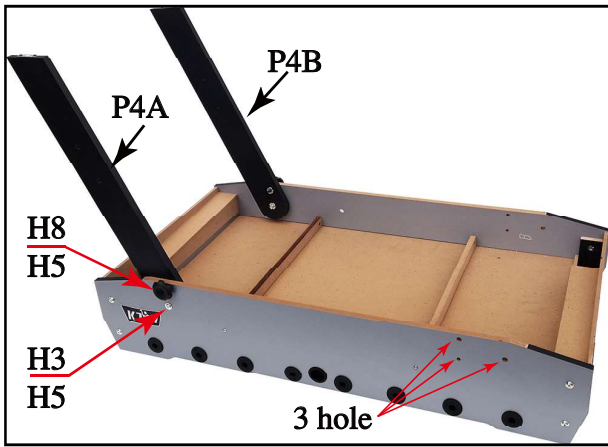

13

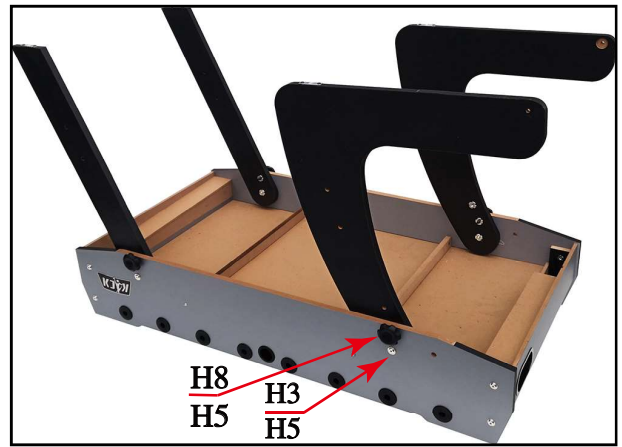

14

6. SCREW THE LEG BOARD **P13** INTO PLACE USING SCREWS **H12**. SEE **FIGURE 15~16**.

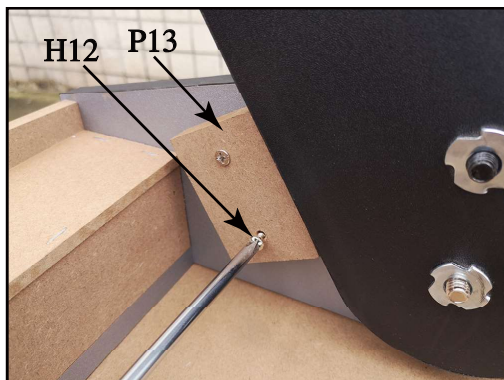

15

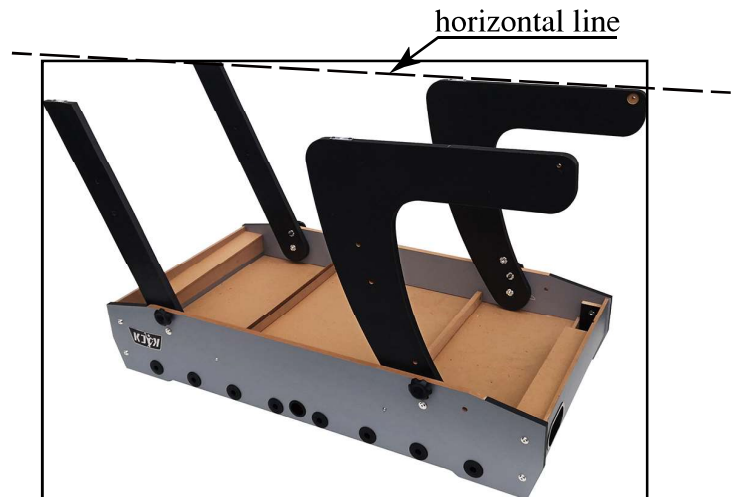

16

7. INSERT THE NUT **H9** INTO THE HOLE OF THE LEG PANEL **P6** . SEE **FIGURE 17**.

8. ATTACH THE LEG PANELS **P6** TO THE STRAIGHT LEGS AND ANGLED LEGS WITH BOLTS **H2** AND WASHERS **H4**.SEE **FIGURE 18**.

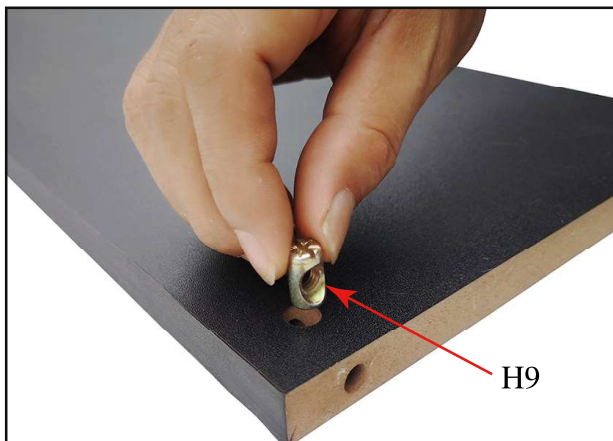

17

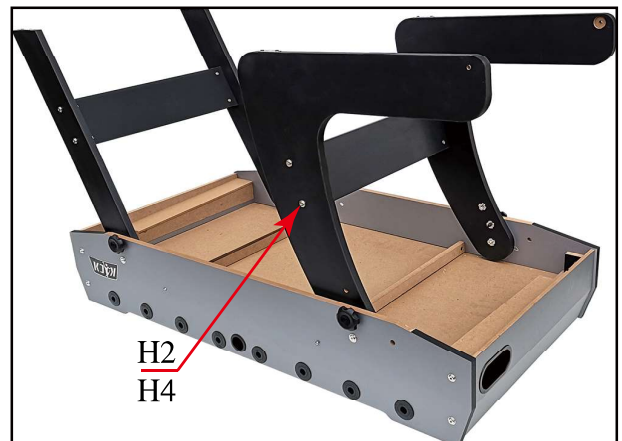

18

Assembly Instructions

WARNING: TWO ADULTS NEEDED TO ASSEMBLE SOCCER TABLE

9. ATTACH THE TUBE **P14** BETWEEN EACH LEGS **P5A&P5B** . INSERT THE BOLT **H14** INTO THE TUBE **P14**, THEN ATTACH THE WHEELS **P11** WITH WASHERS **H6** AND NUT **H7**. SEE **FIGURE 19~20**.

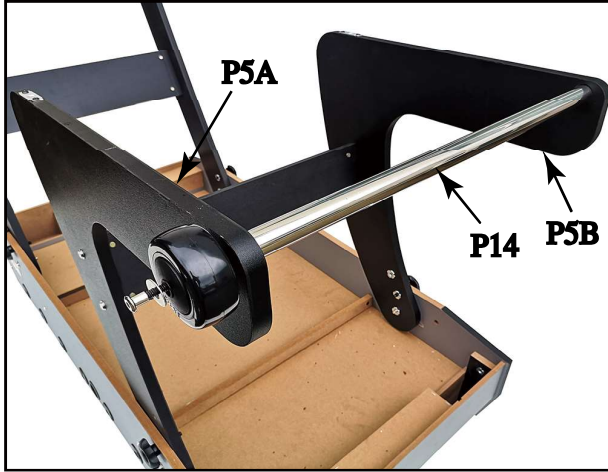

19

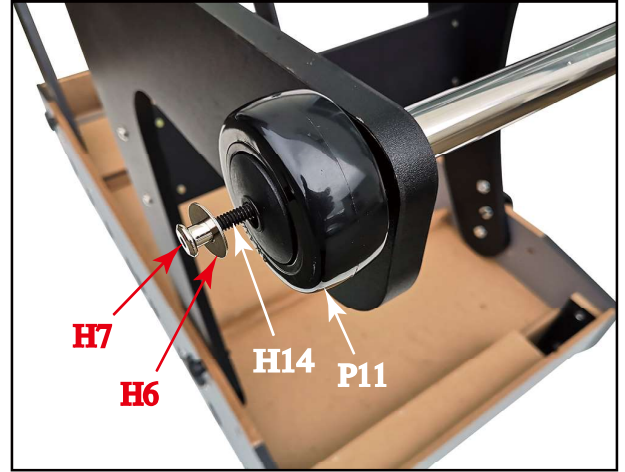

20

10. ATTACH THE LEG LEVELERS **P12**. SEE **FIGURE 21**. *TIGHTEN HARDWARE AT THIS TIME!
VERY CAREFULLY TURN THE TABLE OVER!

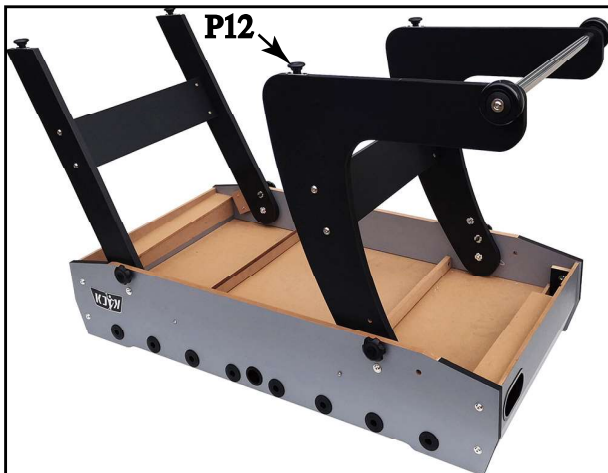

21



22

Assembly Instructions

WARNING: TWO ADULTS NEEDED TO ASSEMBLE SOCCER TABLE

11. ATTACH THE PLASTIC **#2a, #2b, #3a, #3b**, TO THE PLAYING FIELD WITH **S1** .INSERT THE PLUGS **P16** TO COVER THE HOLE. SEE **FIGURE 23~24**.

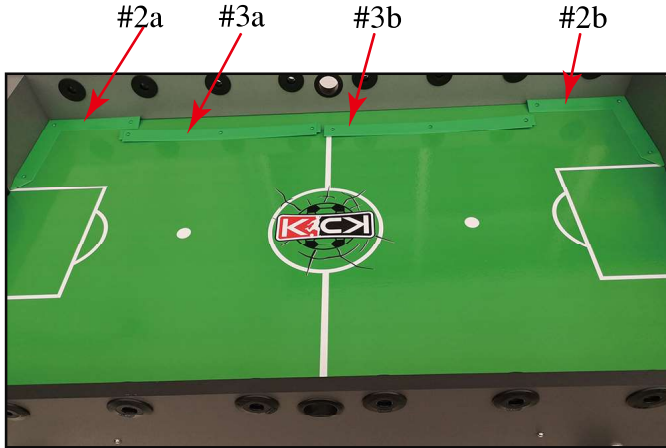

23

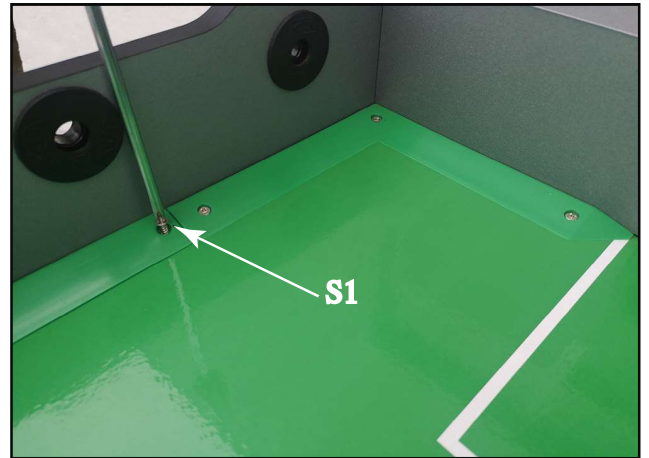

24

12. .INSERT THE PLUGS **P15** TO COVER THE HOLE. SEE **FIGURE 25~26**.

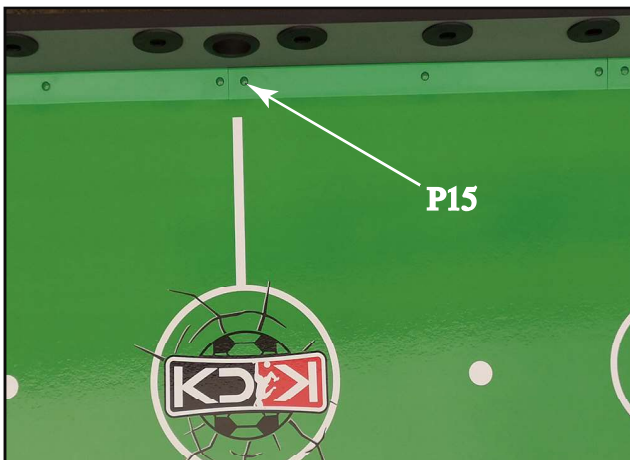

25

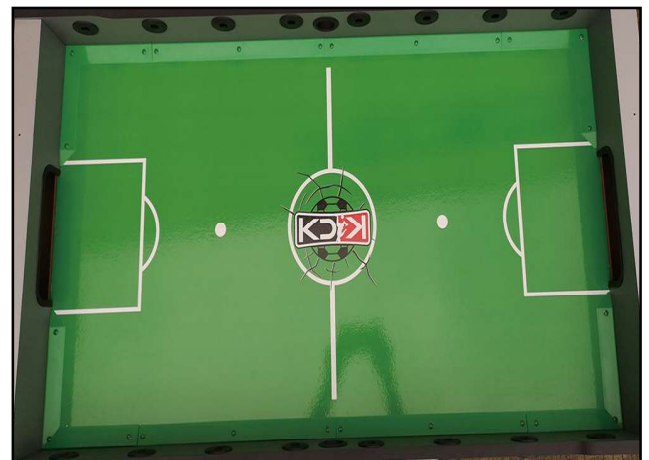

26

Assembly Instructions

WARNING: TWO ADULTS NEEDED TO ASSEMBLE SOCCER TABLE

13. INSERT THE PLAYER RODS **C1&C2&C3** THROUGH ONE SIDE PANEL, THEN INSERT PLAYERS **C8&C9**, RUBBER BUSHINGS **C4**, PLASTIC WASHERS **C5** THROUGH THE ROD, THEN INSERT THE PLAYER ROD THROUGH OTHER SIDE PANEL, ATTACH THE PLAYERS **C8&C9** WITH BOLTS **C6** AND NUTS **C7**. SEE **FIGURE 27~32**.



27

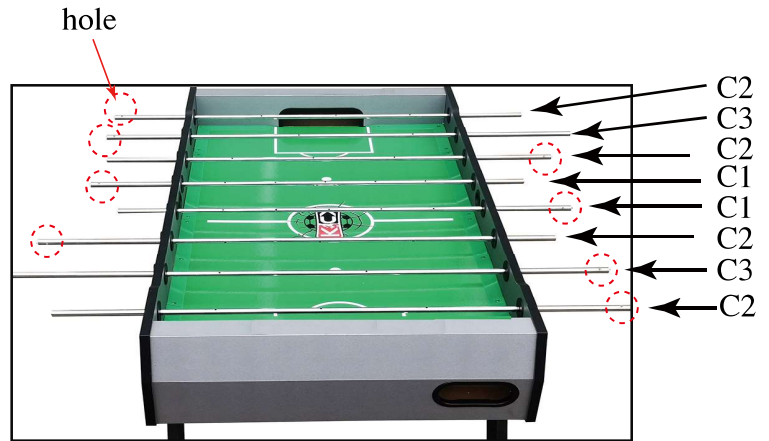

28

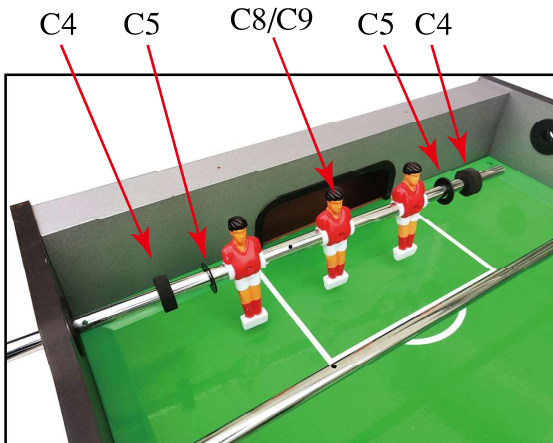

29



30

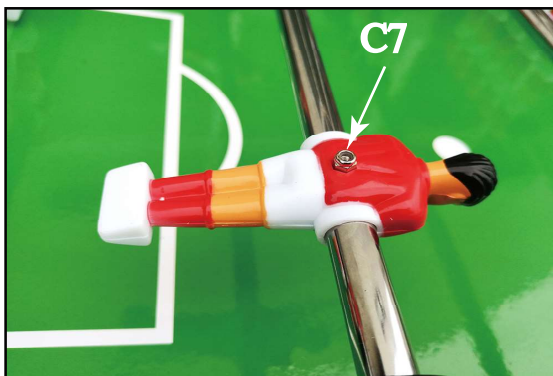

31



32

Assembly Instructions

WARNING: TWO ADULTS NEEDED TO ASSEMBLE SOCCER TABLE

14. SLIDE THE HANDLES **P8** ONTO THE ENDS OF THE RODS SCREW **H15**. SLIDE THE RUBBER CAPS **P9** ON THE OTHER END OF THE ROD. SEE **FIGURE 33**.

15. ATTACH THE SCORER **P10** TO THE END PANEL WITH **H13**. SEE **FIGURE 34~35**.

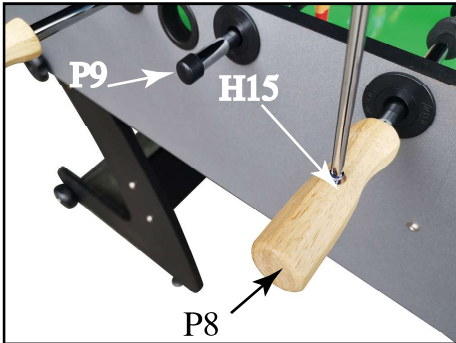

33

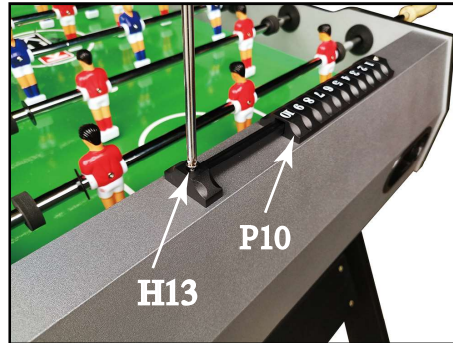

34



35

Warning

Please install the handle according to below correct example. Other wrong operating way may hurt your hands!

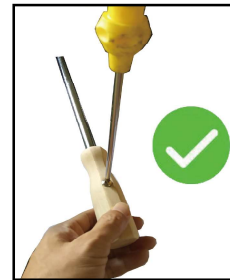
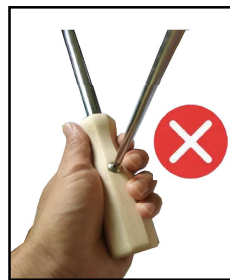

H8
H5

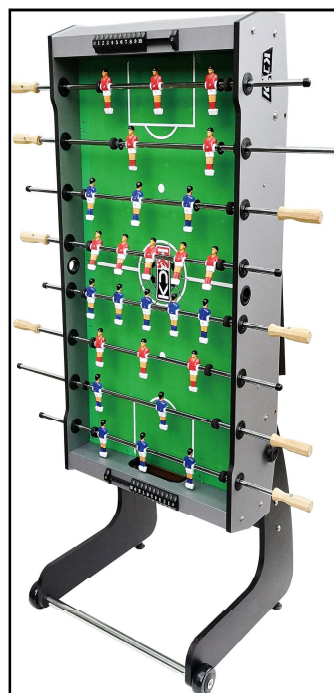

Now that you have completed the assembly successfully, you can now enjoy hours of endless fun with your new KICK Foosball Table

